

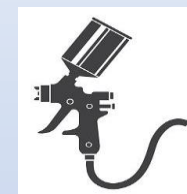

TEMMODAL

TMM

Stainless steel Containers & Packaging Solutions



TEMMODAL SALES / RENTAL & LEASING STAINLESS STEEL CONTAINERS & PACKAGING SOLUTIONS



OUR OFFERS

SALES / RENTAL & LEASING/HIRE-PURCHASE
(Brand new or second hand containers)

Sales Stainless Steel IBC

Rental / Leasing / Hire-Purchase (mid/long term)

Sales second hand containers

Sale Lease back



TEMMODAL SALES / RENTAL & LEASING



OUR SERVICES

- Transport
- Cleaning
- RFID/IoT
- Periodical Inspection
- Maintenance & Repair
- Preventative Maintenance
- Refurbishment/Modifications
- Spare parts Management
- Storage (during open contract)
- Technical assistance/training on site



Several design to meet with your needs

Foodstuff / Beverage : Chocolate, Caramel, Dairy products, fruits preparation, filling, sauces etc. / and beverage : limonade,

- Upon request, containers can be delivered with Kasher, or Halal certifications

Chemical: Hazardous goods (UN approval) or not – all liquid goods which can be carried according to current legislations in force

By submitting your MSDS (product data sheet), our team will have the pleasure to identify the most suitable containers for your goods

Cosmetics: Beauty products, perfumes, Mascara etc.

Painting & Coating: Industrial Painting, Automotive painting, adhesives, glue etc.

OUR STANDARDS & SPECIFICS CONTAINERS (IBC)

To be sold, or to be leased

In order to better answer the market demand, and its customers needs, TEMMODAL has the ability to offer a wide range of industrial containers, under selling, or leasing basis, as well as flexibility on the terms

« Get the ownerships of the containers, make it yours »

or

« simply rent them when you need them »

MANUFACTURING OF TAILOR MADE CONTAINERS



All types of containers for liquid goods (IBCs / stainless steel IBCs) up to 3000L

Technical study according to your needs (material to be transported/stored, size, etc.)

Design according to your specifications (tailor made)

Regulatory and/or preventive maintenance follow-up on request

Management of repairs / technological equipment (GPS, temperature detectors, loading level, pressure)

Financial solution

Ask for a quote @: info@temmodal.fr

Containers approvals

- UN Approval: Transport of dangerous goods
- DOT: Transport of dangerous goods
- CE Approval: Pressure Vessel 97/23/ECC
- ASME: Pressure vessels transport
- ATEX: Explosives atmospheres
- GMP: Good Manufacturing Practices
- EC-1935/2004: Food contact materials
- AD 2000 / ISO 3834-2: Fusion welding



Aseptic Containers

ASEPTIC IBC 45°

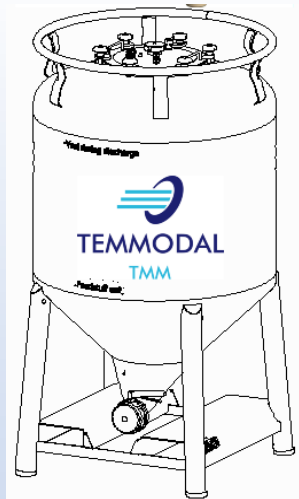

ASEPTIC IBC 30°



LOW HEIGHT
ASEPTIQUE IBC



ASEPTIC IBC 1000L



ASEPTIC IBC BAYONET
COVER



UN CONTAINERS (Hazardous goods or not)

UN IBC INSULATION &
ELECTRIC HEATING

UN IBC CUBIC IN
FRAME

LOW HEIGHT CUBIC IBC

CYLINDRIC IBC IN
FRAME

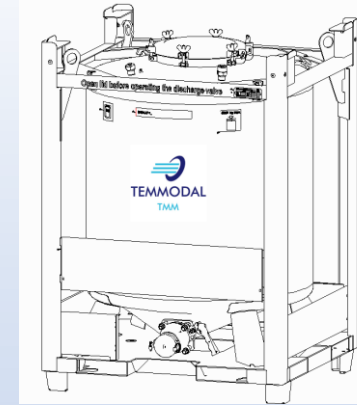
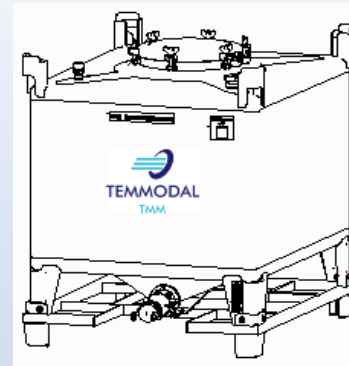
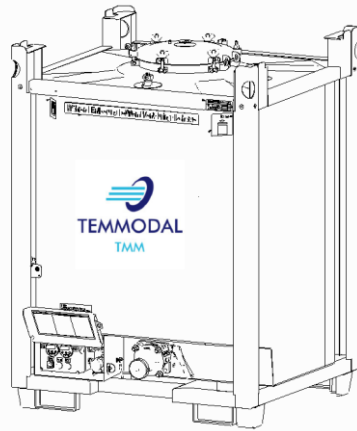

WHY TEMMODAL?

TEMMODAL IS YOUR FLEXIBLE PARTNER

We help you to optimize your fleet

Our twenty years experiences in the industrial fields allow us to think the best option to serve our customers

TEMMODAL is constantly maintaining a good stock level to quickly answer the market demand

Upon request, IBCs are fitted with IoT:

- Geolocation tracking system / Filling-Temperature-Pressure sensors

We offer frame contract on long term vision, the guarantee to have your IBC delivered every year before the start of the pick season



DO YOU WANT TO PURCHASE ?

TEMMODAL WILL SUPPORT YOUR TEAM TO SELECT THE RIGHT CONTAINERS THAT FIT YOUR NEEDS



- Understanding of your needs, as well as your technical requirements (type of utilisation, product, etc.)
- Commercial & technical offer
- Further to customer approval- issue Purchase order
- Order Confirmation by TEMMODAL
- Lead time to produce containers
- FAT « Factory Acceptance Test » (at manufacturing site, or online)
- Delivery of the containers at your premises
- After sales services: Maintenance follow up, regulatory inspections, modifications (services contract)

DO YOU WANT TO RENT ?

TEMMODAL IS YOUR FLEXIBLE PARTNER



- Rental agreement with **TEMMODAL** from mid term (2 years) to long term
- Containers are prepared at our premises in Europe
- Loading / Bottom discharge part can be adjusted to your connections
- For long term contract, Containers can be labelled (sticker with your brand name)
- You pick up the IBC at our “one stop shop” warehouses, or TEMMODAL arrange the transportation to your plant
- Our IBC are all identified with a serial number (manufacturer plate)
- Cleaning, Maintenance & Repair, as well as Return logistics can be ensured by TEMMODAL upon request (unique fee/containers, or at cost), just ask your dedicated sales representative.

RENTING OFFER – HOW DOES IT WORK?

Short operational process

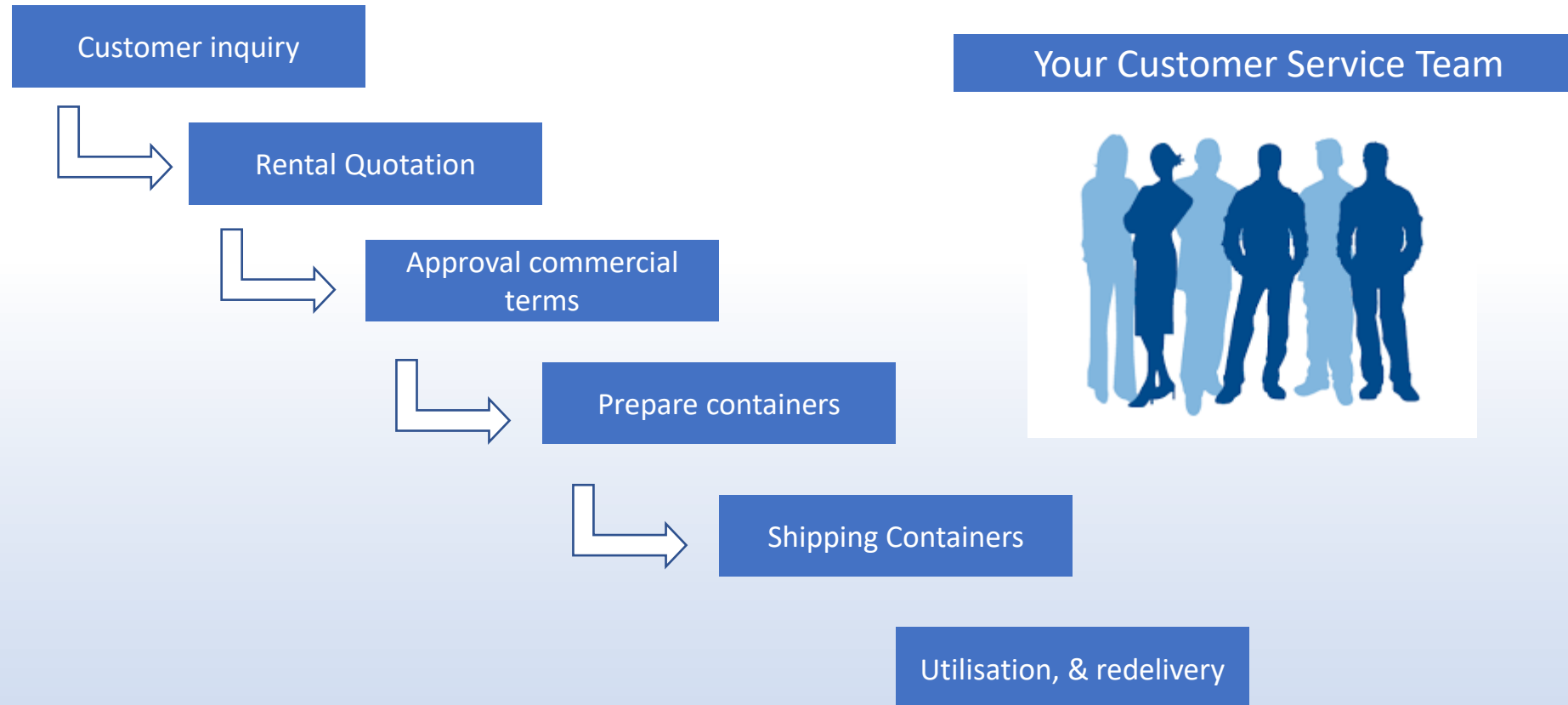

RENTING OFFER

LOGISTICS FLOW



TEMMODAL
TMM

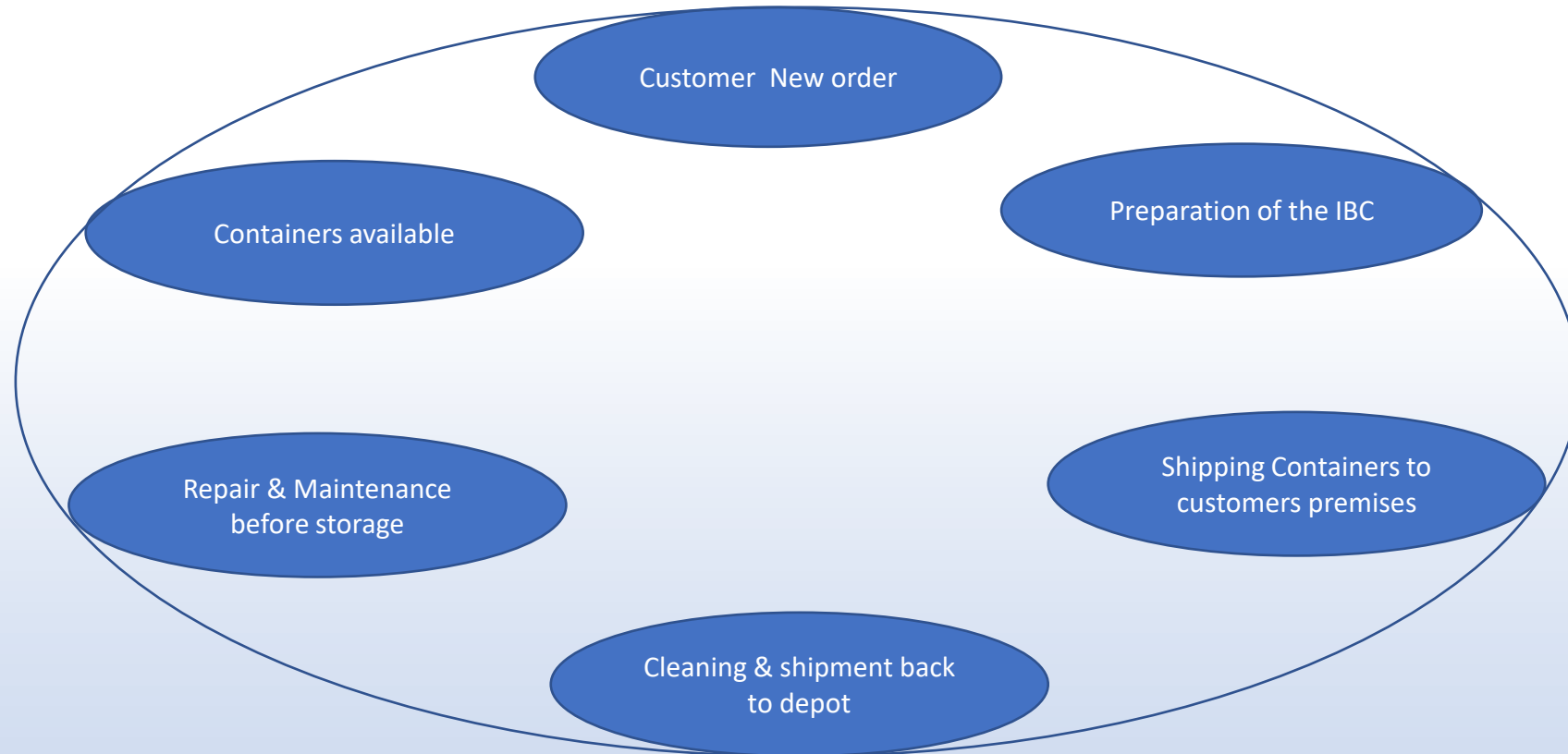

WHAT ARE THE LEASING BENEFITS?

FINANCIAL (FLEXIBILITY) BENEFIT FOR CUSTOMER

- **Balanced Cash Outflow** - Other than a onetime capital expenditure a leasing offers a steady cash outflow over the agreement duration.
- **Tax Benefit** - Leasing expense or lease payments are currently considered as operating expenses, and therefore tax deductible (changes in the law are ongoing)
- **No Capital Expenditure** - Most companies do not require a Capex approval for leasing activities and therefore allows to «make» the investment
- **Preserve Credit Lines** - The financial flexibility of renting equipment enables your company to reserve valuable lines of credit for other growth opportunities.

WHAT ARE THE LEASING BENEFITS?

TECHNICAL/ EXPERTISE

- **Technical expertise** - TEMMODAL can offer expertise in containers solutions and high quality services
- **Complying with the market requirements** - Leasing company owns assets and maintains a high level of standard IBCs. We offer value added services with lease such as:
 - ✓ Repair, Maintenance, refurbishment
 - ✓ Technical advisory
 - ✓ Cleaning, Transportation, delivering of spare parts can be provided
- **State-of-the-Art Equipment** - Renting allows the customer having the latest equipment and technologies available

WHAT ARE THE LEASING BENEFITS?

OPERATIONS OPTIMIZATION

- **Availability** - Customer will benefit of our stock availability, and have containers delivered in very short notice.
- **Seasonality** - Rental solutions help to face seasonal pick or fluctuation in customers production, or customers demand
- **Reduction of business risk** - Customers can rent/lease Containers when needed and where needed. The commitment in terms of duration is limited to the contract term depending on your real need
- **Variation** - Customers can find the right container for the right product, without changing their fleet.
- **Cost optimization** - Maintenance costs can be reduced, as customers can benefit from TMM depot network

CLEANING & REPAIRS

TEMMODAL APPROVED DEPOT NETWORK

IBC CONTAINERS EUROPE 2022

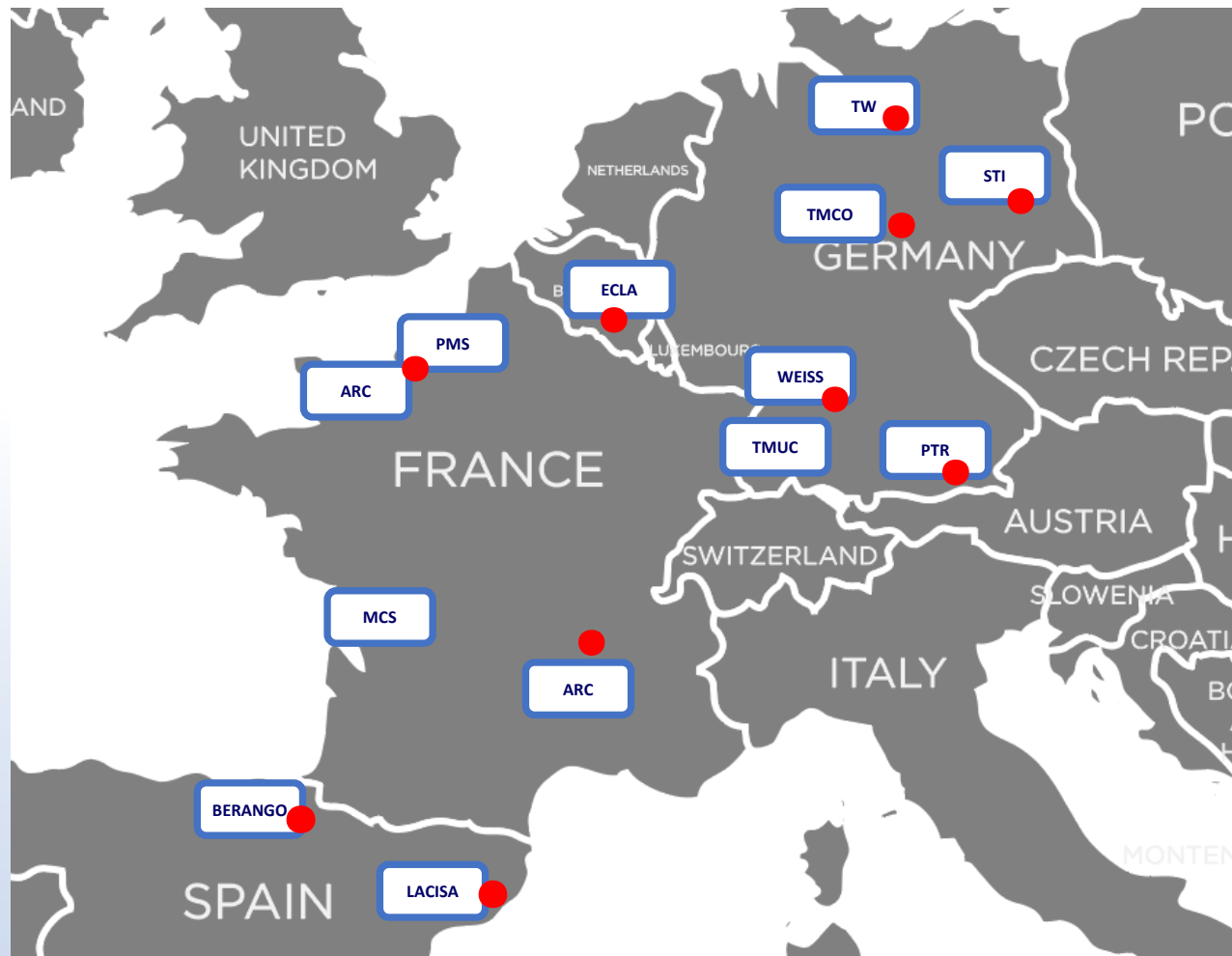

- Depot partner M&R
- Cleaning facilities

[European Tank Cleaning stations | EFTCO](#)

FULL CONTAINER MAINTENANCE CAPABILITY

Periodical testing / management program (on site / or at our premises)

Al type of stainless steel IBC

Using international standards & regulations in force to manage processes

UN test certificates are issued after completion

Maintenance & Repair

Repair of damaged containers

We perform preventive maintenance

Replacement of spare parts

Refurbishment

Our premises refurbish your containers following the state-of-the-art processes

We extend the lifespan of your container



ACCESSORIES & SPARE PARTS



A WIDE RANGE OF ACCESSORIES, SPARE PARTS & CONSUMABLES

Please send your request @ info@temmodal.fr

CONTACT

TEMMODAL

24, rue de Clichy

75009 Paris

+33 1 30 75 27 68

www.temmodal.fr

info@temmodal.fr





THANKS FOR YOUR ATTENTION